



**Event-Driven Indoor Security
IP Camera/Detector
with HD Audio
Installation Manual**

****Compatible with Insite GOLD
and SWAN Server****



**HD78F - Connect Via Wi-Fi with Insite App
HD78 - Bus Wiring and / or Ethernet (HD78)
Wiring Using a CAT5e Cable**

NOTE: Due to the wire size of CAT5 22 gauge wire the maximum length when using CAT5 for powering the HD78 is 150ft.

Wire the HD78/F camera with a single CAT5e or higher cable including two twisted pairs for the 4-wire bus and two twisted pairs for the Ethernet lines. The maximum CAT5e cable length is 50 meters.

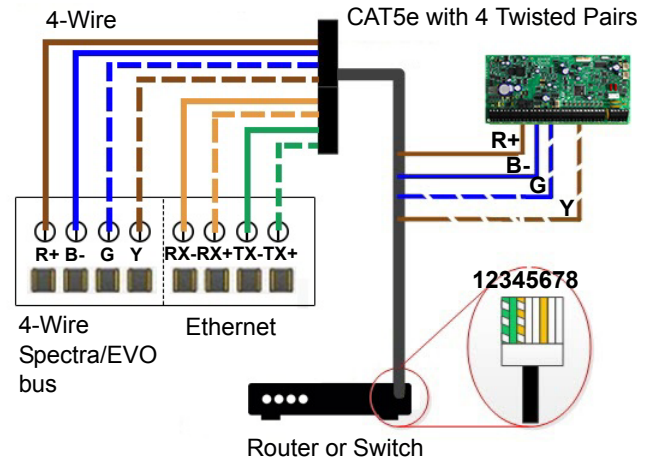

| Recommended Wiring Assignment | | Ethernet Connector | |
|-------------------------------|----------------|--------------------------|----------------|
| Bus Label | Wire Color | Ethernet Wire Assignment | Wire Color |
| R+ | Brown | 1 | Green Striped |
| B- | Blue | 2 | Green |
| G | Blue striped | 3 | Orange Striped |
| Y | Brown striped | 4 | |
| RX- | Orange | 5 | |
| RX+ | Orange striped | 6 | Orange |
| TX- | Green | 7 | |
| TX+ | Green striped | 8 | |

Programming

1. HD78F Connect Power, Open Tamper
2. Phone: Activate hotspot on your Android device, launch the Insite App.
3. Go to menu, select installation.
4. Follow screen instructions.



Introduction

The HD78/F Event-Driven Indoor Security IP Camera combined with its Security Detector provide video/audio solution for security systems. It provides day/night vision at 720P and Hi-Fi audio recording, with over 40 minutes of internal event-recording capacity.

Installing the HD78

WIRING: For bus wire, it is recommended to use 18 gauge wire if distance from the power supply is over 150ft (50m), or wire is feeding more than one camera. Due to battery backup operation conditions, Camera feeding wire (bus) should not have more than 1.0V drop, each camera represents 0.3A max current, wire resistance calculator can be found on the web. Resistance per:

100ft 22 gauge wire = 1.6 Ohm, 18 gauge 0.64 Ohm. Voltage drop formula: $V = 2R \times 0.3N$

(R = Wire resistance, N = Number of cameras fed by the wire, use lower gauge wire if necessary).

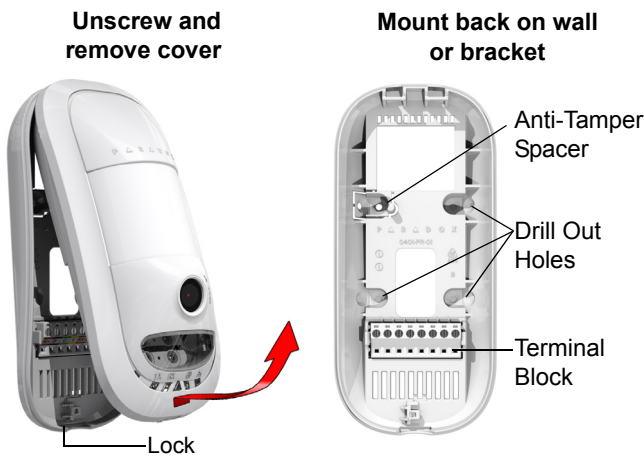

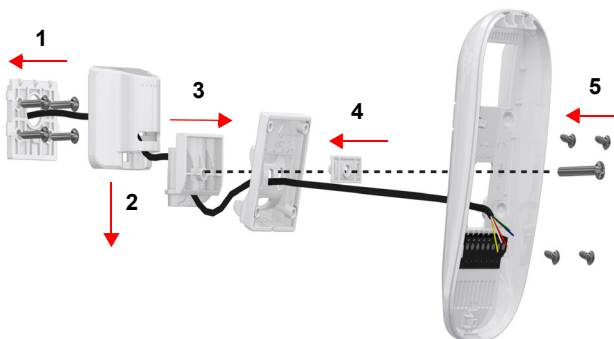

Bracket Mount



LED Status Indicators

Other than PIR detection, LEDs are active when lock mechanism is open.

| LED | Functionality | LED Display |
|---|-------------------------------|--|
| TX | Digiplex/Spectra Data TX | Flashing green: Data transmission Off: No data transmission |
| RX | Digiplex/Spectra Data RX | Flashing green: Data reception Off: No data reception |
|  | Firmware upgrade in progress. | Flashing purple |
| | VOD* | Blue on |
| | Power-up | Flashing blue |
| | Locate mode | Flashing blue |
| | No connection to panel bus | Flashing red |
| | Bus low power | Flashing red |
| | PIR detection | Red on for 3 seconds |
|  | Active Wi-Fi | Green on |
|  | LAN 10/100Mb link | Green on: LAN active |

*VOD On/Off LED is controlled by the Master **ONLY**, using the Insite GOLD application. PIR Detector Beam Patterns

Technical Specifications

| | |
|--------------------------------|---|
| Image Resolution | 1280 x 720 |
| Image Sensor Type | 1.4 megapixels, CMOS sensor, 7V/LUX.Sec |
| Streaming Video | 720p H.264 10 FPS |
| HD Audio | 16 bit, 24 KHz sampling rate, 32 Kb/s mono |
| Pre-event recording | 3 seconds (day color mode) |
| Internal storage | 4 GB |
| Detection Speed | 0.2 m/s to 2.5 m/s (0.6 ft/s to 11.5 ft/s) |
| Voltage Input | Nominal: 12VDC, range 9-16VDC |
| Current Consumption Max | 350mA - IR illumination ON 250mA - IR illumination OFF 100mA - System lost AC / Battery operation |
| PIR Type | Quad PIR, auto pulse, dual edge, digital detector |
| Dimensions / Weight | H x W x D: 15 x 7.1 x 6cm (6 x 2.8 x 2.4in) / 163g (5.75oz) |
| Operating Temperature | -20° C to +40° C (-4° F to 104° F) |
| Compliance | EN 50131-2-2 Grade 2 Environmental Class II |
| Installation Height | 2.1m - 2.7m (7ft - 9ft) |
| Installation options | Wall or corner, swivel bracket optional |
| Compatibility | SP5500, SP6000 and SP7000 |

Top View

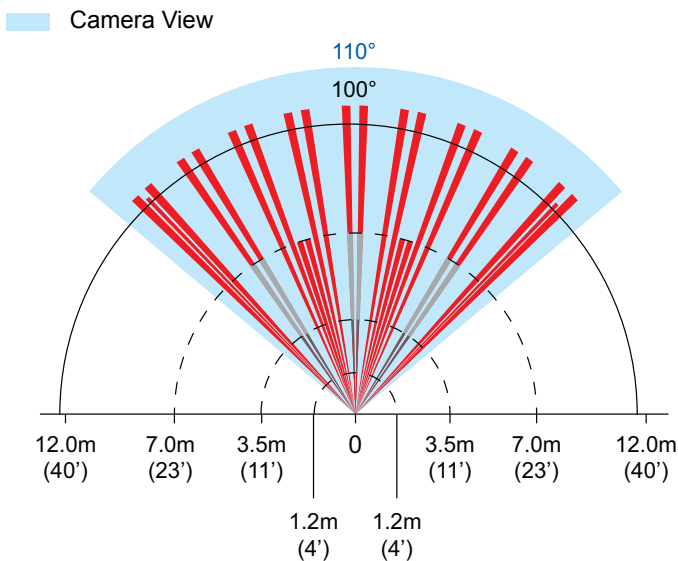

Side View

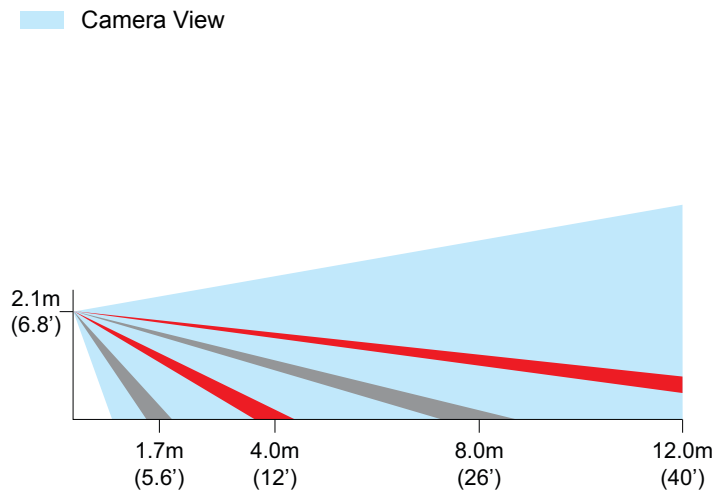

Warranty

For complete warranty information on this product, please refer to the Limited Warranty Statement is found on the website: www.paradox.com/terms or contact your local distributor. Specifications may change without prior notice.

Patents

US, Canadian and international patents may apply. Paradox is a trademark or registered trademark of Paradox Security Systems (Bahamas) Ltd.